



January 2010

## FEATURES

- \* Isolation voltage between input and output  $V_{iso} : 5,000V_{rms}$
- \* 6pin DIP photocoupler, triac driver output
- \* High repetitive peak off-state voltage  $V_{DRM} : \text{Min. } 400V$
- \* High critical rate of rise of off-state voltage  
(  $dV/dt : \text{MIN. } 100V / \mu s$  )
- \* Dual-in-line package :  
MOC3020, MOC3021, MOC3022, MOC3023
- \* Wide lead spacing package :  
MOC3020M, MOC3021M, MOC3022M, MOC3023M
- \* Surface mounting package :  
MOC3020S, MOC3021S, MOC3022S, MOC3023S
- \* Tape and reel packaging :  
MOC3020S-TA1, MOC3021S-TA1, MOC3022S-TA1, MOC3023S-TA1
- \* Safety approval  
UL / CSA / FIMKO / VDE\* approved  
\*Required "V" ordering option

## APPLICATIONS

- \* Motor Controls
- \* Solid state relays
- \* For triggering high power thyristor and triac
- \* Household use equipment

## OUTLINE DIMENSIONS

### Dual-in-line package :

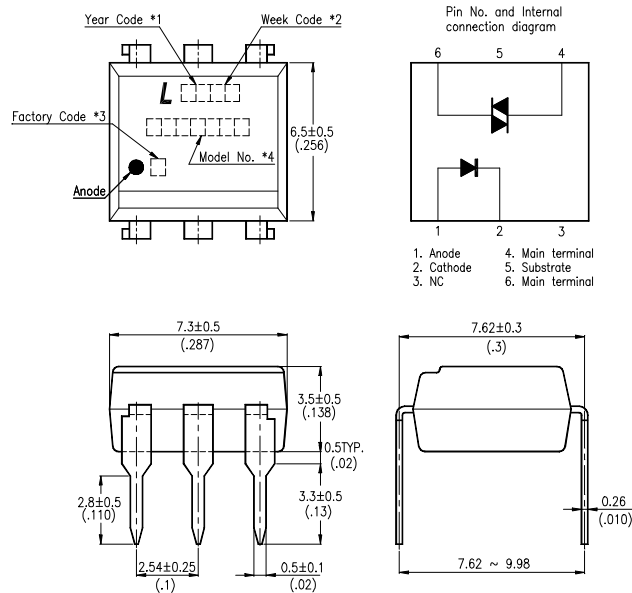

### Wide lead spacing package:

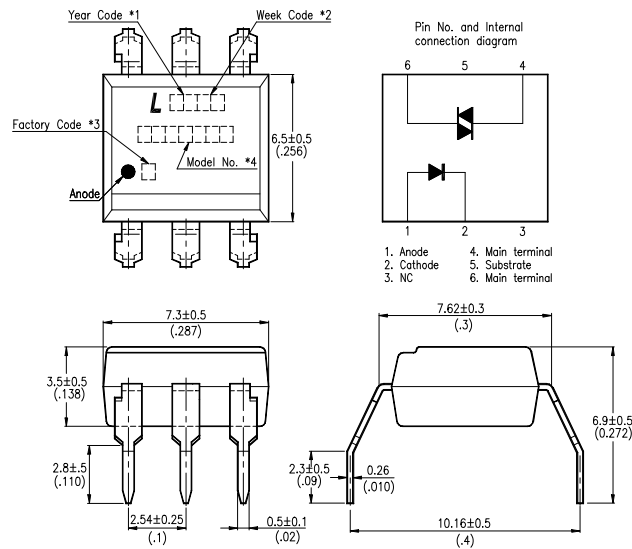

- \*1. Year date code.
- \*2. 2-digit work week.
- \*3. Factory identification mark shall be marked.  
(Z : Taiwan, Y : Thailand, X : China-TJ, W : China-CZ)
- \*4. Model No.: MOC3020 ; MOC3021 ; MOC3022 ; MOC3023

## OUTLINE DIMENSIONS

Surface mounting package :

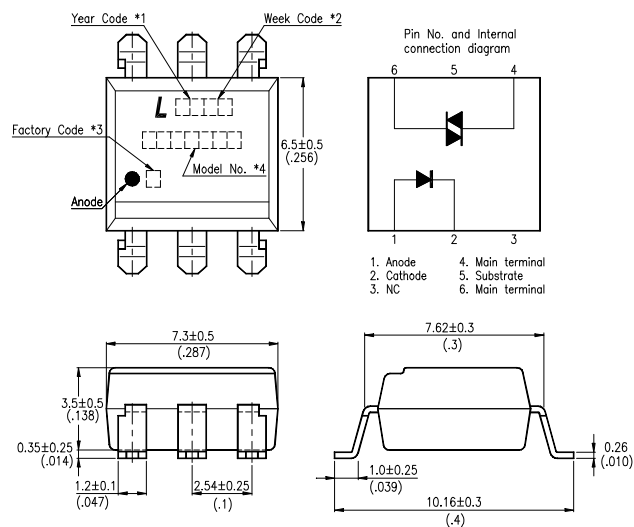

- \*1. Year date code.
- \*2. 2-digit work week.
- \*3. Factory identification mark shall be marked.  
(Z : Taiwan, Y : Thailand, X : China-TJ, W : China-CZ)
- \*4. Model No.: MOC3020 ; MOC3021 ; MOC3022 ; MOC3023

## TAPING DIMENSIONS

**Tape and reel package ( TYPE II ):**

**MOC3020S-TA1, MOC3021S-TA1, MOC3022S-TA1, MOC3023S-TA1**

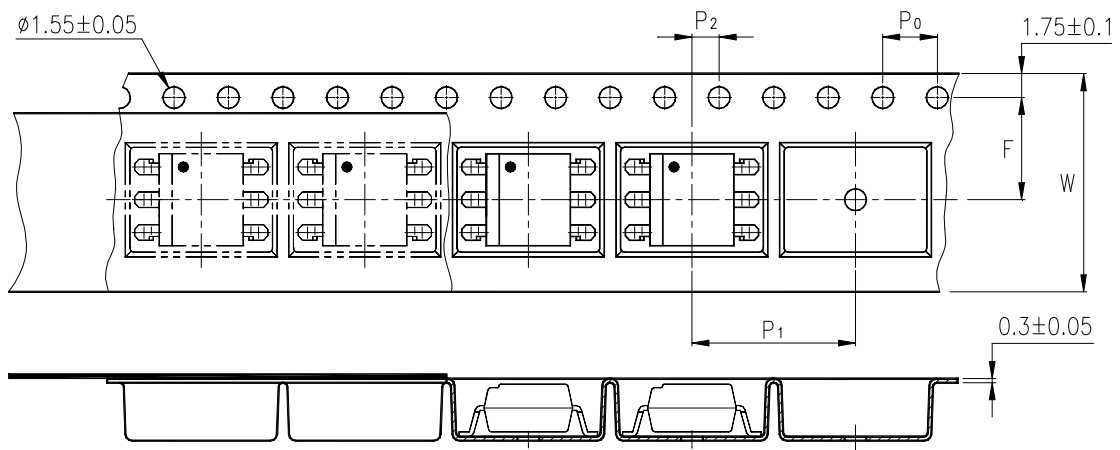

Description	Symbol	Dimensions in mm ( inches )
Tape wide	W	$16 \pm 0.3$ ( .63 )
Pitch of sprocket holes	$P_0$	$4 \pm 0.1$ ( .15 )
Distance of compartment	F	$7.5 \pm 0.1$ ( .295 )
Distance of compartment to compartment	$P_2$	$2 \pm 0.1$ ( .079 )
Distance of compartment to compartment	$P_1$	$12 \pm 0.1$ ( .472 )

**ABSOLUTE MAXIMUM RATING**

( Ta = 25°C )

PARAMETER		SYMBOL	RATING	UNIT
INPUT	Forward Current	I <sub>F</sub>	50	mA
	Reverse Voltage	V <sub>R</sub>	6	V
	Power Dissipation	P <sub>D</sub>	70	mW
OUTPUT	Off-State Output Terminal Voltage	V <sub>DRM</sub>	400	V
	Peak Repetitive Surge Current ( PW=1ms, 120pps )	V <sub>TSM</sub>	1	A
	Collector Power Dissipation	P <sub>C</sub>	300	mW
Total Power Dissipation		P <sub>tot</sub>	330	mW
*1	Isolation Voltage	V <sub>iso</sub>	5,000	V <sub>rms</sub>
Ambient Operating Temperature Range		T <sub>A</sub>	-40 ~ +100	°C
Storage Temperature Range		T <sub>stg</sub>	-55 ~ +150	°C
*2	Soldering Temperature	T <sub>L</sub>	260	°C

\*1. AC For 1 Minute, R.H. = 40 ~ 60%

Isolation voltage shall be measured using the following method.

- (1) Short between anode and cathode on the primary side and between collector, emitter on the secondary side.
- (2) The isolation voltage tester with zero-cross circuit shall be used.
- (3) The waveform of applied voltage shall be a sine wave.

\*2. For 10 Seconds

## ELECTRICAL - OPTICAL CHARACTERISTICS

( Ta = 25°C )

PARAMETER		SYMBOL	MIN.	TYP.	MAX.	UNIT	CONDITIONS	
INPUT	Forward Voltage	$V_F$	—	1.15	1.5	V	$I_F=20\text{mA}$	
	Reverse Current	$I_R$	—	—	10	$\mu\text{A}$	$V_R=6\text{V}$	
OUTPUT	*1 Peak Blocking Current, Either Direction	$I_{\text{DRM}}$	—	10	100	nA	$V_{\text{DRM}} = 400\text{V}$	
	Peak On-State Voltage, Either Direction	$V_{\text{TM}}$	—	1.7	3	V	$I_{\text{TM}}=100\text{ mA Peak}$	
	*2 Critical rate of Rise of Off-State Voltage	dv/dt	100	—	—	V/ $\mu\text{s}$		
COUPLED	*3 Led Trigger Current, Current Required to Latch Output, Either Direction	MOC3020	$I_{\text{FT}}$	—	15	30	mA	Main Terminal Voltage = 3V
		MOC3021		—	8	15		
		MOC3022		—	—	10		
		MOC3023		—	—	5		
	Holding Current, Either Direction	$I_H$	250	—	—	$\mu\text{A}$		

\*1 Test voltage must be applied within dv/dt rating.

\*2 This is static dv/dt. Commutating dv/dt is a function of the load-driving thyristor(s) only.

\*3 All devices are guaranteed to trigger at an  $I_F$  value less than or equal to max  $I_{\text{FT}}$ . Therefore, recommended operating  $I_F$  lies between max  $I_{\text{FT}}$ , 30 mA for MOC3020, 15 mA for MOC3021, 10 mA for MOC3022, 5 mA for MOC3023, and absolute max  $I_F$  (50mA)

### CHARACTERISTICS CURVES

Fig.1 Forward Current vs. Ambient Temperature

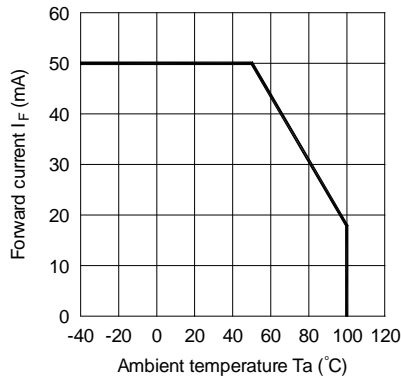

Fig.2 On-state Current vs. Ambient Temperature

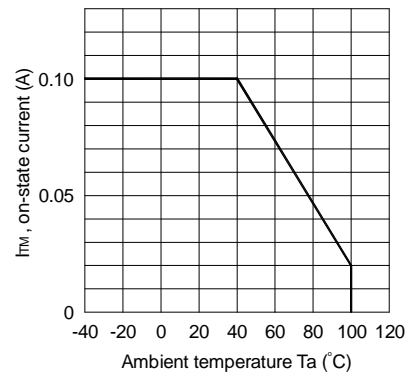

Fig.3 Minimum Trigger Current vs. Ambient Temperature

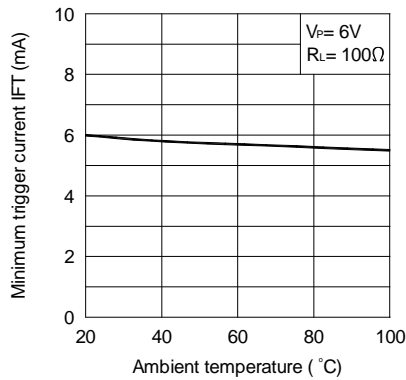

Fig.4 Forward Current vs. Forward Voltage

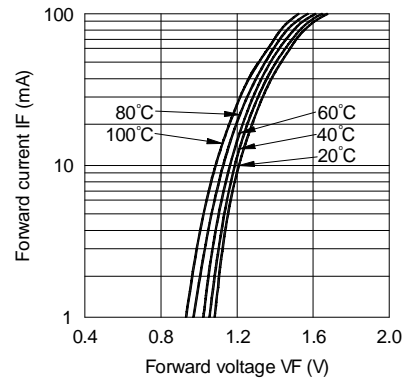

Fig.5 On-state Voltage vs. Ambient Temperature

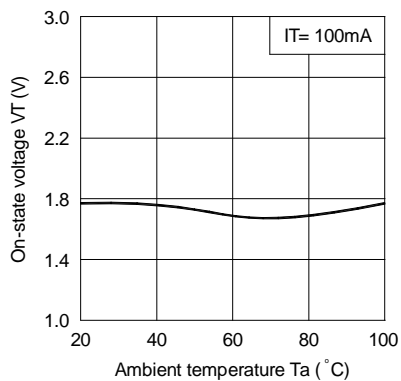
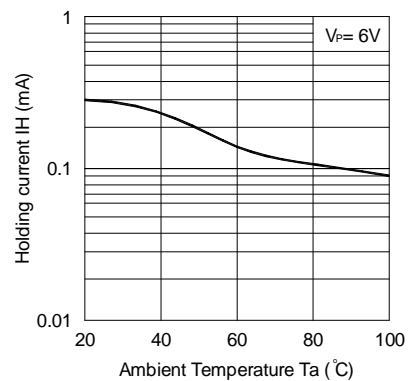

Fig.6 Holding Current vs. Ambient Temperature



## CHARACTERISTICS CURVES

Fig. 7 Repetitive Peak Off-state Current vs. Temperature

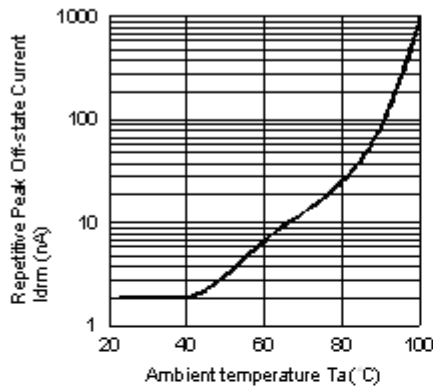
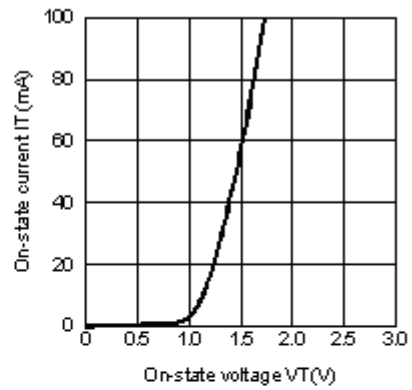
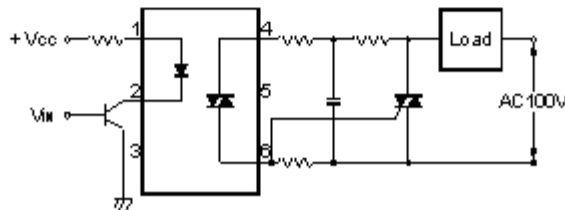

Fig. 8 On-state Current vs. On-state Voltage



Basic Operation Circuit  
Medium/High Power Triac Drive Circuit



## RECOMMENDED FOOT PRINT PATTERNS (MOUNT PAD)

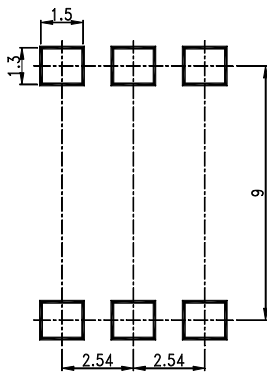

Unit : mm



### **Notes:**

- Lite-On is continually improving the quality, reliability, function or design and Lite-On reserves the right to make changes without further notices.
- The products shown in this publication are designed for the general use in electronic applications such as office automation equipment, communications devices, audio/visual equipment, electrical application and instrumentation.
- For equipment/devices where high reliability or safety is required, such as space applications, nuclear power control equipment, medical equipment, etc, please contact our sales representatives.
- When requiring a device for any "specific" application, please contact our sales in advice.
- If there are any questions about the contents of this publication, please contact us at your convenience.
- The contents described herein are subject to change without prior notice.

# Mouser Electronics

Authorized Distributor

Click to View Pricing, Inventory, Delivery & Lifecycle Information:

## Lite-On:

[MOC3023S](#) [MOC3021S](#) [MOC3022S](#) [MOC3020S](#) [MOC3021](#) [MOC3020](#) [MOC3022](#) [MOC3023](#) [MOC3020S-TA](#)  
[MOC3020S-TA1](#) [MOC3021S-TA](#) [MOC3021S-TA1](#) [MOC3022S-TA](#) [MOC3022S-TA1](#) [MOC3023S-TA](#) [MOC3023S-](#)  
[TA1](#) [MOC3020M](#) [MOC3021M](#) [MOC3022M](#) [MOC3023M](#)